

## A simple bench

This project is easy — no fancy joints or glue — and inexpensive. We paid about \$45 for the dimensional cedar at a local home improvement center.

"Cutting curves" shows how to cut the curved seat, the most complicated part. Or you can leave the seat flat.

Round off slat edges by sanding. Then arrange seat slats until you like the way they look *before* drilling and fastening them. And finish the bench with exterior oil to keep the cedar color or let it "gray" naturally. □

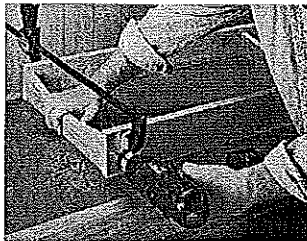
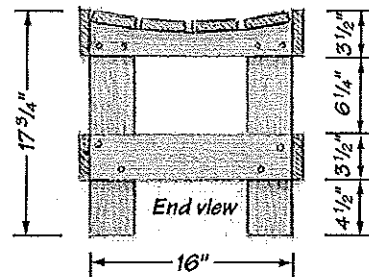
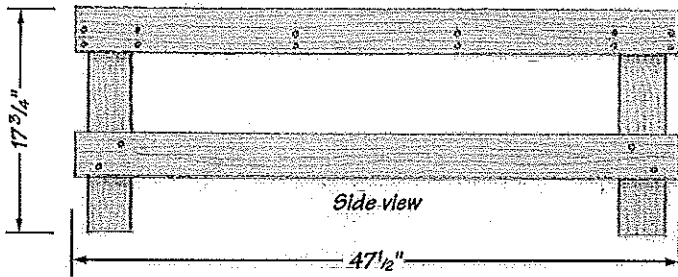
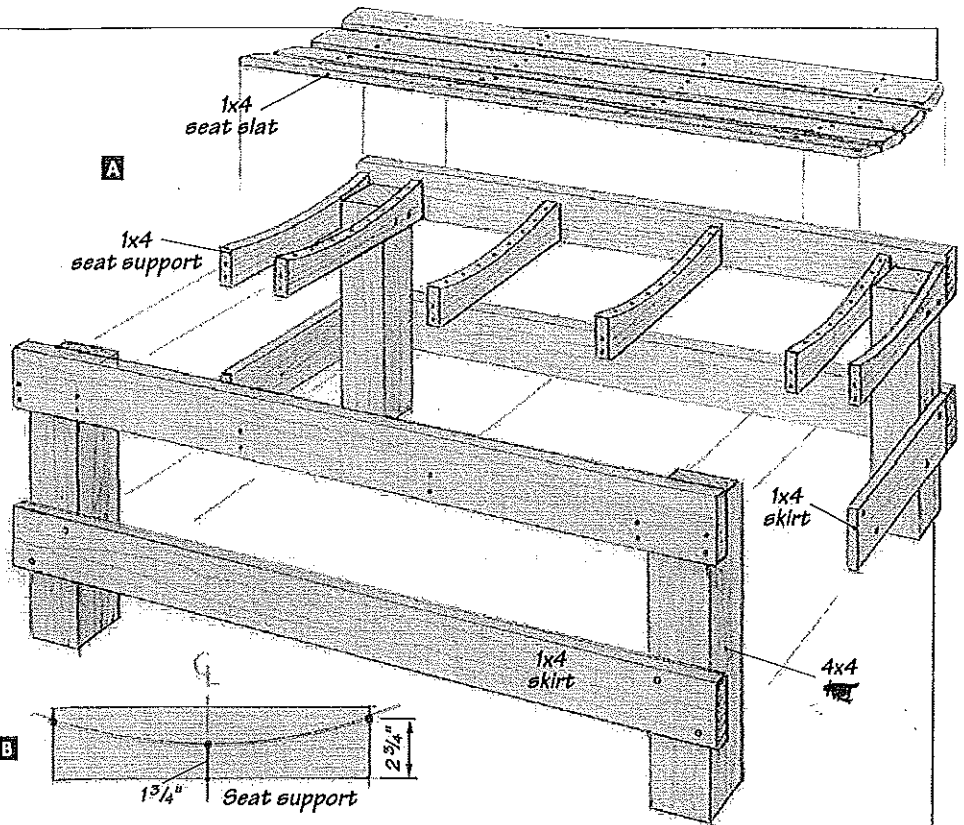

**{ Step one —** Cut wood to length and assemble seat box. Clamp in place and attach with deck screws. Pre-drill holes according to illustration A to prevent splitting.

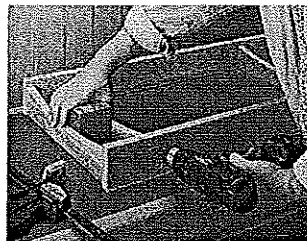

**{ Step two —** Starting from the ends, add the middle four seat supports. Attach screws through long side pieces. Use scraps from legs as spacers for two outside supports.

### CUTTING CURVES

To cut the curves in the seat supports, first measure and mark the three points as shown in illustration B on one support. While a friend holds a flexible ruler on the three points, draw the curve. After cutting out the curve with a coping or saber saw, use the piece as a template for the other five support pieces. Always remember to keep the "good" side of the wood facing out.

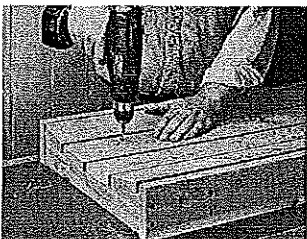

**{ Step three —** Sand and then evenly space out the four seat slats on top of seat supports. Fasten to the four innermost seat supports only (eight screws per slat).

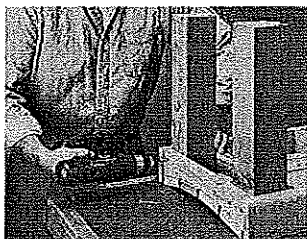

**{ Step four —** Flip seat and place legs between seat supports. Holding legs snug in corners, drill and screw in place. Sand bottom edges of legs.

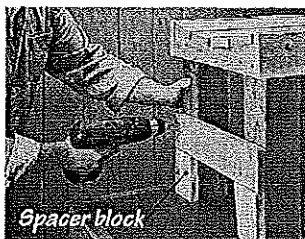

**{ Step five —** Cut two 4 1/2-in. spacer blocks to support skirt legs while attaching to legs. Do the ends first, lining up with edges of legs, then attach long side pieces.

### JUST THE FACTS

**Materials:**

- 8 cedar boards 1x4x16 in. (6 with curves cut, if desired)
- 8 cedar boards 1x4x47 1/2 in.
- 4 cedar posts 4x4x16 3/4 in.
- 56 2-in. deck screws
- 32 1 1/4-in. deck screws (for seat slats)
- 1 qt. exterior oil finish

**Tools:**

Ruler, square, hand and coping or saber saws, clamps, drill with 1/8-in. bit, Phillips driver bit, sandpaper